

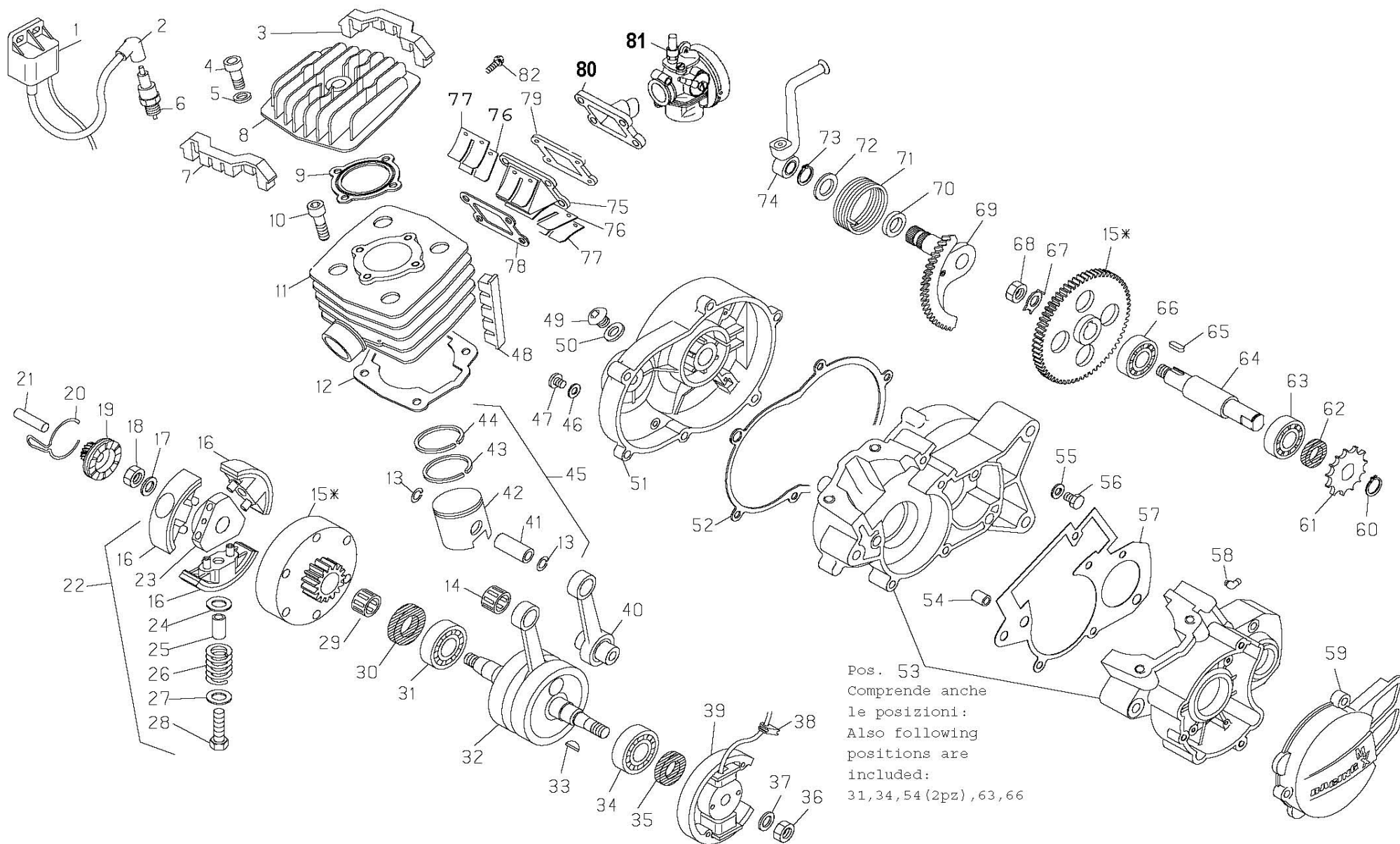

mod. BETA R-10 2010

17/09/10





Pos. 53
 Comprende anche
 le posizioni:
 Also following
 positions are
 included:
 31, 34, 54 (2pz), 63, 66



motore/engine R10 2010

Cod. 3742828 100
08/06/2010

N. POS.	CODICE NUMBER	DESCRIZIONE	DESCRIPTION
1	11-20631	BOBINA ATE	ELECTRONIC H.T. COIL
2	27-13512	RACCORDO CANDELA	SPARK PLUG PROTECTOR
3	16-21062	GOMMA ANTIVIBRAZIONI TESTA POST.	HEAD ANTIVIBRACTIONS RUBBER
4	31-45000	VITE TCCE M6X30	SCREW 6X30
5	27-40500	RONDELLA 6X13	WASHER 6X13
6	12-25200	CANDELA RN 3C SCHERMATA	SPARK PLUG 3N 3C
7	16-21061	GOMMA ANTIVIBRAZIONI TESTA ANT.	HEAD ANTIVIBRACTIONS RUBBER
8	29-12038-0-59	TESTA	CYLINDER HEAD
9	16-64100	GUARNIZIONE TESTA	GASKET
10	31-63890	VITE TCCE M8X20	SCREW 8X20
11	12-52501-0-59	CILINDRO	CYLINDER
12	16-61750	GUARNIZIONE CILINDRO-CARTER	CYLINDER CRANKCASE GASKET
13	10-42010	ANELLO FERMA SPINOTTO	CIRCLIP
14	16-11500	GABBIA 12X15X15	NEEDLE BEARING 12X15X15
15	29-06916-8	TRASMISSIONE PRIMARIA C/CAMPANA	PRIMARY DRIVE
16	22-30105-8	MASSETTA	CLUTCH PAD
17	27-58500-0-60	RONDELLA SPESS. 10X17	WASHER 10X17
18	13-20200	DADO SPEC. 10X1,25X6	SPECIAL NUT 10X1,25X6
19	22-14540	MANICOTTO MM	KICKSTARTER SLEEVE
20	22-58040	MOLLA MANICOTTO MM	SPRING
21	25-43911	PERNO 8X32	PIN 8X32
22	15-08876-8	FRIZIONE COMPLETA	CLUTCH ASSY
23	22-90019	MOZZO FRIZIONE	CLUTCH HUB
24	27-58061-0-50	RONDELLA SPESS. 8X15X0,50	SPECIAL WASHER 8X15X0,5
25	29-09577	TUBETTO PER MOLLA	SPACER
26	22-37890	MOLLA FRIZIONE	SPRING
27	27-58061-0-15	RONDELLA SPESS. 8X15X0,15	SPECIAL WASHER 8X15X0,15
28	11-49511	BULLONE 6X25	BOLT 6X25
29	16-12905	GABBIA 15X18X17	NEEDLE BEARING 15X18X17
30	10-62020	ANELLO PARAOLIO 17X35X7	OIL SEAL 17X35X7
31	12-96000	CUSCINETTO 17X40X12	BALL BEARING 17X40X12
32	10-00725	ALBERO MOTORE	CRANKSHAFT
33	12-45000	CHIAVETTA 2,5X3,7	WOODRUFF KEY 2.5X3.7
34	12-96000	CUSCINETTO 17X40X12	BALL BEARING 17X40X12
35	10-56010	ANELLO PARAOLIO 15X24X7	OIL SEAL 15X24X7
36	13-19020	DADO M10X1,25	SPECIAL NUT 10X1,25X6
37	27-58500-0-60	RONDELLA	WASHER
38	16-33510	GOMMINO PASSAFILI VOLANO	GROMMET
39	31-03262	VOLANO MAGNETE	ELECTRIC FLYWHEEL
40	11-03740-8	BIELLA COMPLETA	CONNECTING ROD ASSY
41	28-93610	SPINOTTO	PISTON PIN
42	25-80264	PISTONE D.39,5 PER GHISA	PISTON
43	28-60160	SEGMENTO	PISTON RING
44	28-60160	SEGMENTO	PISTON RING
45	25-03410-8	PISTONE COMPLETO D.39,5	COMPL. PISTON
46	16-47500	GUARNIZIONE 6X12X1,5	GASKET 6X12X1,5
47	31-30490-0-51	VITE M6X8	SCREW 6X8
48	16-21031	GOMMA ANTIVIBRAZ. CILINDRO	CYLINDER ANTIVIBR. RUBBER
49	29-10290	TAPPO OLIO	OIL PLUG
50	16-53600	GUARNIZIONE 16X22,5X1	GASKET 16X22,5X1
51	12-62113-0-33	COPERCHIO FRIZIONE	CLUTCH COVER
52	16-71530	GUARNIZIONE COPERCHIO FRIZIONE	CLUTCH COVER GASKET
53	12-06311-8	CARTER COMPLETO (pos.31,34,54(2pz),63,66)	CRANKCASE (pos.31,34,54(2pz),63,66)
54	16-36500	GRANO RIFERIMENTO CARTER 9X10	DOWEL 9X10
55	16-50510	GUARNIZIONE RAME 10X1,5X1	GASKET 10X15X1 COPPER

N. POS.	CODICE NUMBER	DESCRIZIONE	DESCRIPTION
56	11-58000	GOMMA ANTIVIBRAZ. CILINDRO	SPECIAL BOLT
57	16-55050	TAPPO OLIO	GRANKCASE GASKET
58	27-23380	GUARNIZIONE 16X22,5X1	BREATHER PIPE HOSE
59	12-70110-0-33	COPERCHIO VOLANO	MAGNETO COVER
60	28-23600	SEEGER 15E	SEEGER 15E
61	25-61111	PIGNONE CATENA Z.10	SPROCKET Z.10
62	10-54000	ANELLO PARAOLIO 15X24X5	OIL SEAL 15X24X5
63	12-94000	CUSCINETTO 15X35X11	BALL BEARING 15X35X11
64	10-26150	ALBERO RINVIO	TRANSMISSION SHAFT
65	12-46160	CHIAVETTA 5X5X12	WOODRUFF KEY 5X5X12
66	12-94000	CUSCINETTO 15X35X11	BALL BEARING 15X35X11
67	27-74760	RONDELLA FERMADADO ø14	SPECIAL WASHER D.14
68	13-28950	DADO M14X1,25	SPECIAL NUT 14X1,25
69	22-05084	MESSA IN MOTO	KICKSTARTER
70	10-56015	ANELLO PARAOLIO 16X22X4	OIL SEAL 16X22X4
71	22-79040	MOLLA RITORNO LEVA MESSA IN MOTO	KICKSTARTER SPRING
72	27-67510	RONDELLA 16X25X1	WASHER 16X25X1
73	28-23600	SEEGER 15E	SEEGER 15E
74	21-55112	LEVA MESSA IN MOTO	KICKSTARTER LEVER
75	31-02120	VALVOLA ASPIRAZIONE COMPLETA	REED VALVE
76	21-15360	LAMELLA PER VALVOLA	VALVE'S BLADE
77	25-59670	PIASTRINA PER LAMELLA	VALVE'S PLATE
78	16-92550	GUARNIZIONE VALVOLA	VALVE' S GASKET
79	16-83530	GUARNIZIONE RACCORDO CARBURATORE	VALVE' S PLATE
80	27-19741	RACCORDO CARBURATORE	INLET MANIFOLD
81	12-04470	CARBURATORE DELL'ORTO SHA 15/15	CARBURETOR
82	11-50010	BULLONE 6X25	BOLT 6X25

PARTICOLARI NON FIGURANTI / SUPPLEMENTARY PARTS LIST

20-02854	KIT GOMME ANTIVIBRAZIONE	ANTIVIBRATION SET
28-06886-8	SERIE ANELLI PARAOLIO	OIL SEAT SET
28-08075-8	SERIE GUARNIZIONI	GASKET SET
25-03415-8	PISTONE COMPLETO D.40	COMPL. PISTON D.40
25-80267	PISTONE D.40 PER GHISA	PISTON
28-60171	SEGMENTO	PISTON RING
28-60171	SEGMENTO	PISTON RING



motore/engine R10 2010 2°vers

cod.3742828.400 08/06/2010

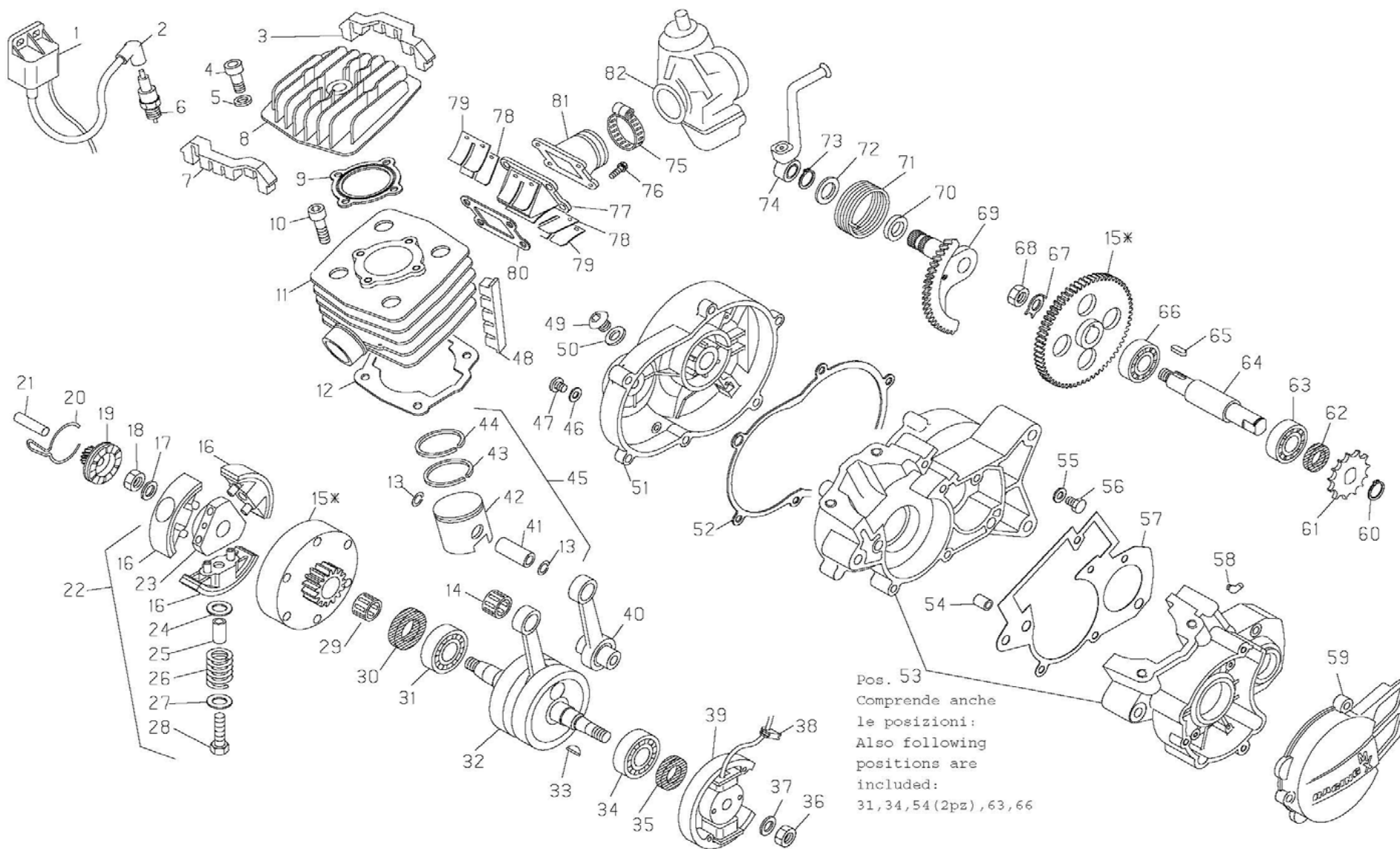



motore/engine R10 2010 2°vers.

Cod. 3742828 400
08/06/2010

N. POS.	CODICE NUMBER	DESCRIZIONE	DESCRIPTION
1	11-20631	BOBINA ATE	ELECTRONIC H.T. COIL
2	27-13512	RACCORDO CANDELA	SPARK PLUG PROTECTOR
3	16-21062	GOMMA ANTIVIBRAZIONI TESTA POST.	HEAD ANTIVIBRACTIONS RUBBER
4	31-45000	VITE TCCE M6X30	SCREW 6X30
5	27-40500	RONDELLA 6X13	WASHER 6X13
6	12-25200	CANDELA RN 3C SCHERMATA	SPARK PLUG 3N 3C
7	16-21061	GOMMA ANTIVIBRAZIONI TESTA ANT.	HEAD ANTIVIBRACTIONS RUBBER
8	29-12038-0-59	TESTA	CYLINDER HEAD
9	16-64100	GUARNIZIONE TESTA	GASKET
10	31-63890	VITE TCCE M8X20	SCREW 8X20
11	12-52501-0-59	CILINDRO	CYLINDER
12	16-61750	GUARNIZIONE CILINDRO-CARTER	CYLINDER CRANKCASE GASKET
13	10-42010	ANELLO FERMA SPINOTTO	CIRCLIP
14	16-11500	GABBIA 12X15X15	NEEDLE BEARING 12X15X15
15	29-06916-8	TRASMISSIONE PRIMARIA C/CAMPANA	PRIMARY DRIVE
16	22-30105-8	MASSETTA	CLUTCH PAD
17	27-58500-0-60	RONDELLA SPESS. 10X17	WASHER 10X17
18	13-20200	DADO SPEC. 10X1,25X6	SPECIAL NUT 10X1,25X6
19	22-14540	MANICOTTO MM	KICKSTARTER SLEEVE
20	22-58040	MOLLA MANICOTTO MM	SPRING
21	25-43911	PERNO 8X32	PIN 8X32
22	15-08876-8	FRIZIONE COMPLETA	CLUTCH ASSY
23	22-90019	MOZZO FRIZIONE	CLUTCH HUB
24	27-58061-0-50	RONDELLA SPESS. 8X15X0,50	SPECIAL WASHER 8X15X0,5
25	29-09577	TUBETTO PER MOLLA	SPACER
26	22-37890	MOLLA FRIZIONE	SPRING
27	27-58061-0-15	RONDELLA SPESS. 8X15X0,15	SPECIAL WASHER 8X15X0,15
28	11-49511	BULLONE 6X25	BOLT 6X25
29	16-12905	GABBIA 15X18X17	NEEDLE BEARING 15X18X17
30	10-62020	ANELLO PARAOLIO 17X35X7	OIL SEAL 17X35X7
31	12-96000	CUSCINETTO 17X40X12	BALL BEARING 17X40X12
32	10-00725	ALBERO MOTORE	CRANKSHAFT
33	12-45000	CHIAVETTA 2,5X3,7	WOODRUFF KEY 2.5X3.7
34	12-96000	CUSCINETTO 17X40X12	BALL BEARING 17X40X12
35	10-56010	ANELLO PARAOLIO 15X24X7	OIL SEAL 15X24X7
36	13-19020	DADO M10X1,25	SPECIAL NUT 10X1,25X6
37	27-58500-0-60	RONDELLA	WASHER
38	16-33510	GOMMINO PASSAFILI VOLANO	GROMMET
39	31-03262	VOLANO MAGNETE	ELECTRIC FLYWHEEL
40	11-03740-8	BIELLA COMPLETA	CONNECTING ROD ASSY
41	28-93610	SPINOTTO	PISTON PIN
42	25-80264	PISTONE D.39,5 PER GHISA	PISTON
43	28-60160	SEGMENTO	PISTON RING
44	28-60160	SEGMENTO	PISTON RING
45	25-03410-8	PISTONE COMPLETO D.39,5	COMPL. PISTON
46	16-47500	GUARNIZIONE 6X12X1,5	GASKET 6X12X1,5
47	31-30490-0-51	VITE M6X8	SCREW 6X8
48	16-21031	GOMMA ANTIVIBRAZ. CILINDRO	CYLINDER ANTIVIBR. RUBBER
49	29-10290	TAPPO OLIO	OIL PLUG
50	16-53600	GUARNIZIONE 16X22,5X1	GASKET 16X22,5X1
51	12-62113-0-33	COPERCHIO FRIZIONE	CLUTCH COVER
52	16-71530	GUARNIZIONE COPERCHIO FRIZIONE	CLUTCH COVER GASKET
53	12-06311-8	CARTER COMPLETO (pos.31,34,54(2pz),63,66)	CRANKCASE (pos.31,34,54(2pz),63,66)
54	16-36500	GRANO RIFERIMENTO CARTER 9X10	DOWEL 9X10
55	16-50510	GUARNIZIONE RAME 10X1,5X1	GASKET 10X15X1 COPPER

N. POS.	CODICE NUMBER	DESCRIZIONE	DESCRIPTION
56	11-58000	GOMMA ANTIVIBRAZ. CILINDRO	SPECIAL BOLT
57	16-55050	TAPPO OLIO	GRANKCASE GASKET
58	27-23380	GUARNIZIONE 16X22,5X1	BREATHER PIPE HOSE
59	12-70110-0-33	COPERCHIO VOLANO	MAGNETO COVER
60	28-23600	SEEGER 15E	SEEGER 15E
61	25-61111	PIGNONE CATENA Z.10	SPROCKET Z.10
62	10-54000	ANELLO PARAOLIO 15X24X5	OIL SEAL 15X24X5
63	12-94000	CUSCINETTO 15X35X11	BALL BEARING 15X35X11
64	10-26150	ALBERO RINVIO	TRANSMISSION SHAFT
65	12-46160	CHIAVETTA 5X5X12	WOODRUFF KEY 5X5X12
66	12-94000	CUSCINETTO 15X35X11	BALL BEARING 15X35X11
67	27-74760	RONDELLA FERMADADO ø14	SPECIAL WASHER D.14
68	13-28950	DADO M14X1,25	SPECIAL NUT 14X1,25
69	22-05084	MESSA IN MOTO	KICKSTARTER
70	10-56015	ANELLO PARAOLIO 16X22X4	OIL SEAL 16X22X4
71	22-79040	MOLLA RITORNO LEVA MESSA IN MOTO	KICKSTARTER SPRING
72	27-67510	RONDELLA 16X25X1	WASHER 16X25X1
73	28-23600	SEEGER 15E	SEEGER 15E
74	21-55112	LEVA MESSA IN MOTO	KICKSTARTER LEVER
75	15-15370	FASCETTA PER CARBURATORE	CLAMP
76	11-49070	BULLONE C/RONDELLA 6X20	BOLT 6X20
77	31-02140	VALVOLA ASPIRAZIONE COMPLETA	REED VALVE
78	21-15360	LAMELLA PER VALVOLA	VALVE'S BLADE
79	25-59670	PIASTRINA PER LAMELLA	VALVE'S PLATE
80	16-92550	GUARNIZIONE VALVOLA	VALVE' S GASKET
81	27-23051	RACCORDO CARBURATORE	INLET MANIFOLD
82	15-05075	CARBURATORE	CARBURETOR

PARTICOLARI NON FIGURANTI / SUPPLEMENTARY PARTS LIST

13-46691	DISTANZIALE RIDUZIONE ASPIRAZIONE	SPACER
20-02854	KIT GOMME ANTIVIBRAZIONE	ANTIVIBRATION SET
28-06886-8	SERIE ANELLI PARAOLIO	OIL SEAT SET
28-08075-8	SERIE GUARNIZIONI	GASKET SET
25-03415-8	PISTONE COMPLETO D.40	COMPL. PISTON D.40
25-80267	PISTONE D.40 PER GHISA	PISTON
28-60171	SEGMENTO	PISTON RING
28-60171	SEGMENTO	PISTON RING



mod. R-10 MY10

01/01/2010

FIGURA	CODICE	DESCRIZIONE	DESCRIPTION	Q.TÁ
REF.NBR.	CODE			Q.TY

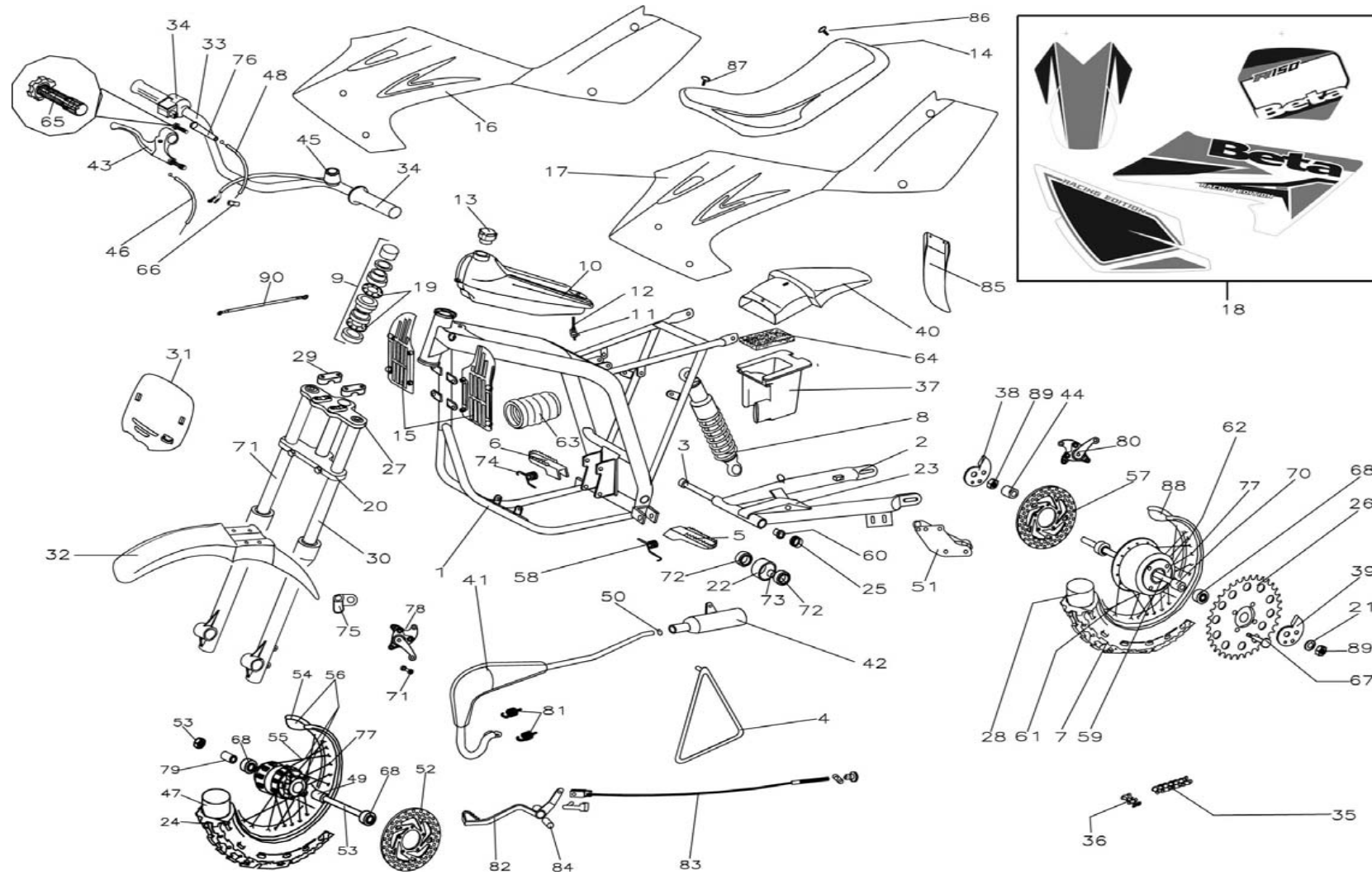

mod. **R-10 MY10**

01/01/2010

FIGURA REF.NBR.	CODICE CODE	DESCRIZIONE	DESCRIPTION	Q.TÁ Q.TY
1	011310008 000	TELAIO NERO	BLACK FRAME	1
2	011330020 000	FORCELLONE ARGENTO	SILVER SWING-ARM	1
3	2547093 000	VITE T.E. 12x170	SWING ARM AXLE W/NUT	1
4	011320040 000	CAVALLETTO TRIANGOLO PICCOLO VERNICIATO	SILVER PAINTED SIDE STAND	1
5	2532453 000	STAFFA SX BIANCA ZINCATA MOD. ECONOMICI	FOOT PEG LEFT	1
6	2532453 000	STAFFA DX ZINCATA BIANCA MOD. ECONOMICI	FOOT PEG RIGHT	1
7	1278260 000	COPERTURA POST 2.75 x 10^	FRONT - REAR TIRE	1
8	011330008 000	AMMORTIZATORE	REAR SHOCK ABSORBER	1
9	011340180 000	SERIE STERZO	STEERING HEAD SET CPL	1
10	2805418 059	SERBATOIO NERO	GAS TANK	1
11	2779600 000	RUBINETTO BENZINA CON GUARNIZIONE	GAS VALVE CPL WITH O-RING	1
12	1650550 000	GUARNIZIONE RUBINETTO BENZINA	GAS VALVE O-RING W/CUP	1
13	2900525 059	TAPPO SERBATOIO	GAS CAP	1
14	011430040 000	SELLA BASSA NERA-ROSSA	BLACK/RED SEAT	1
15	1645539 000	COPPIA GRIGLIE RADIATORE	RADIATOR GRILL	1



mod. R-10 MY10

01/01/2010

FIGURA REF.NBR.	CODICE CODE	DESCRIZIONE	DESCRIPTION	Q.TÁ Q.TY
16	1518508 051	FIANCATA DESTRA BETA R10 BIANCA	RADIATOR SPOILER RIGHT WHITE	1
17	1518507 051	FIANCATA SINISTRA BETA R10 BIANCA	RADIATOR SPOILER LEFT WHITE	1
18	011430018 051	SERIE ADESIVI R10 MY 2010	COMPLETE SET "LEM " STICKERS	1
19	011340020 000	SFERE X SERIE STERZO	STEEL BOWL(WITH BALL)	2
20	011340120 000	CROCIERA INFERIORE	STEERING STEM	1
21	2759901 000	RONDELLA PIANA RUOTA	WASHER FOR FRONT AND REAR WHEEL 23,5 ,	1
22	2784250 000	RULLO GUIDA CATENA x CUSCINETTI	ROLLER WITH BUSHING SLOT	1
23	2910095 059	SLITTA TENDICATENA	CHAIN GUIDE	1
24	1278262 000	COPERTURA ANTERIORE 2.50-12	R3 FRONT TIRE 2.50 x 12^	1
25	1631010 000	GOMMINO PARAPOLVERE FORCELLONE	SWINGARM DUST SEAL	2
26	011420140 000	CORONA Z.42	REAR SPROCKET 42 TEETH	1
27	2950197 057	CROCIERA SUPERIORE FORCELLA	TRIPLE CLAMP TOP	1
28	1215258 000	CAMERA 275 x 10^	FRONT - REAR AIR TUBE 10^	1
29	01134008 000	CAVALLOTTO FERMA MANUBRIO	HANDLEBAR CLAMP	2
30	011340140 000	GAMBALE SINISTRO+CANNA	FR L SHOCK ABSORBER	1

mod. **R-10 MY10**

01/01/2010

FIGURA REF.NBR.	CODICE CODE	DESCRIZIONE	DESCRIPTION	Q.TÁ Q.TY
31	2592272 052	PORTANUMERO ANT. NERO	FRONT NUMBER PLATE BLACK	1
32	2514974 051	PARAFANGO ANT.BIANCO	FRONT FENDER WHITE	1
33	2200558 057	MANUBRIO VERNICIATO	HANDLEBAR PAINTED	1
34	1208820 000	COMANDO GAS C/MANOPOLA	THROTTLE ASSY CPL WITH GRIPS	1
35	1207165 000	CATENA 92 PASSI C/GIUNTO 1/2x3/16	CHAIN 92 LINKS	1
36	2211170 000	MAGLIA CONGIUNZIONE PER CATENA	CHAIN MASTER LINK	1
37	2812675 059	SCATOLA FILTRO	AIR BOX	1
38	2911891 000	TIRACATENA DX	CHAIN ADJUSTER R/S	1
39	2911892 000	TIRACATENA SX	CHAIN ADJUSTER L/S	1
40	2518854 051	PARAFANGO POSTERIORE BIANCO	REAR FENDER WHITE	1
41	011370030 000	MARMITTA CROMATA	EXHAUST PIPE	1
42	2891972 000	SILENZIATORE VERNICIATA	MUFFLER FOR	1
43	011360118 000	LEVA FRENO ANT.	FRONT BRAKE LEVER	1
44	011420160 000	DISTANZIALE RUOTA POST. DX 20 X 14,5	RIGHT SPACING FOR REAR WHEEL ø 20 x 14,5	1
45	011400050 000	INTERRUT.A STRAPPO MAGNETICO	MAGNETIC TEAR SWITCH	1

mod. **R-10 MY10**

01/01/2010

FIGURA REF.NBR.	CODICE CODE	DESCRIZIONE	DESCRIPTION	Q.TÁ Q.TY
46	011360000 000	TRASMISSIONE FRENO ANT.	FRONT BRAKE CABLE R/S	1
47	1215259 000	CAMERA ANTERIORE 2.50 x 12^	FRONT AIR TUBE 2.50 x 12^	1
48	011350070 000	TRASMISSIONE GAS COMPLETA	THROTTLE CABLE CPL	1
49	011410060 000	DISTANZIALE RUOTA ANT. SX Ø 20 X 16,5	LEFT SPACING FOR FRONT WHEEL Ø 20 x 16,5	1
50	1042840 000	O-R x SILENZIATORE	MUFFLER O-RING	1
51	011420060 000	CRUNA GUIDA CATENA COMP.	CHAIN GUIDE COMPONENTS	1
52	011360060 000	DISCO FRENO ANT. D.180 NIFO 4 FORI	FRONT DISC BRAKE Ø 180	1
53	011410010 000	PERNO RUOTA ANT. COMP.	FRONT WHEEL AXLE	1
54	011410080 000	CERCHIO RUOTA ANTERIORE 12"	FRONT RIM 12"	1
55	011410090 000	RAGGI RUOTA ANTERIORE	FRONT WHEEL SPOKES	32
56	011410020 000	RUOTA ANTERIORE 12^ SENZA COPERTURA	FRONT WHEEL CPL 12" (W/OUT TIRE)	1
57	13392160 000	DISCO FRENO POST. 150 ART.	REAR DISC BRAKE Ø 150	1
58	2247108 000	MOLLA STAFFA SX MOD. DM ZINCATA BIANCA	FOOT PEG SPRING R/S	1
59	011420070 000	PERNO RUOTA POSTERIORE 12X192 ZINCATO	REAR WHEEL AXLE Ø12 x 192	1
60	1126460 000	BOCCOLA FORCELLONE NYLON D. 20 x 12	NYLON BUSH FOR SWING-ARM	2

mod. **R-10 MY10**

01/01/2010

FIGURA REF.NBR.	CODICE CODE	DESCRIZIONE	DESCRIPTION	Q.TÁ Q.TY
61	011420200 000	RAGGI RUOTA POSTERIORE	REAR WHEEL SPOKES	32
62	011420080 000	RUOTA POSTERIORE 10" SENZA COPERTURA	REAR WHEEL CPL 10" (W/OUT TIRE)	1
63	2213405 000	SOFFIETTO SCATOLA FILTRO D.64 L.105	AIR BOX BOOT	1
64	1525170 000	FILTRO ARIA 85x85x20	AIR FILTER	1
65	2726026 000	REGISTRO GAS	GAS CABLE ADJUSTER	1
66	2585501 000	MORSETTO GAS	THROTTLE CABLE CLAMP	1
67	011420190 000	VITE CORONA T.E. 8x30	SPROCKET SCREW 8 x 30	4
68	1294010 000	CUSCIN.RUOTA SKF 6202 15X35X11 2RS	REAR WHEEL BUSHING	2
70	011420170 000	DISTANZIALE RUOTA POST. SX. 20 X 22	SPACING FOR REAR WHEEL Ø 20 x 22	1
71	011340130 000	GAMBALE DESTRO+CANNA	FR R SHOCK ABSORBER	1
72	1293457 000	CUSCINETTO 608-2RS PER RULLO TENDICATENA	CHAIN ROLLER BUSHING	2
73	1126461 000	BOCCOLA INTERNA PER RULLO TENDICATENA	INSIDE BUSH FOR CHAIN ROLLER	1
74	2247108 000	MOLLA STAFFA DX ZINCATA BIANCA MOD. DM	FOOT PEG SPRING L/S	1
75	2525225 000	PASSAFILO GAMBALE ART. SPN-05	GUILDING-SLIT FORK	1
76	2893065 000	SOFFIETTO COPRIREGOL.	RUBBER PIPETTE FOR GAS ADJUSTE	1

mod. **R-10 MY10**

01/01/2010

FIGURA REF.NBR.	CODICE CODE	DESCRIZIONE	DESCRIPTION	Q.TÁ Q.TY
77	2310050 000	NIPPLES PER RAGGI RUOTA	NIPPLES FOR SPOKES	64
78	2102095 000	PINZA FRENO ANTERIORE ART. LEA36110	FRONT BRAKE PLIERS	1
79	011410070 000	DISTANZIALE RUOTA ANT. DX Ø 20 X 11	RIGHT SPACING FOR FRONT WHEEL ø 20 x 11	1
80	011360058 000	PINZA FRENO POSTERIORE COMPLETA DX-2/3	REAR BRAKE ASSY	1
81	011370000 000	MOLLA TUBO SCARICO	EXHAUST-PIPE SPRING	2
82	2528093 000	PEDALE FRENO POSTERIORE	REAR FOOT BRAKE PEDAL	1
83	011360030 000	TRASMISSIONE FRENO POST.	REAR FOOT BRAKE PEDAL CABLE, COMPLETE	1
84	1126464 000	BOCCOLA PEDALE FRENO 13x22 foro 8,2	BUSH FOR REAR FOOT BRAKE PEDAL	1
85	2524423 000	PARASPRUZZO IN POLIETILENE	MUD FLAPS LX2 RACER	1
86	3145123 000	VITE PER SELLA ALLUMINIO D. 6x20	SCREW FOR SEAT ALLUMINIUM 6x20	1
87	3145124 000	VITE PER SELLA ALLUMINIO D. 6x26	SCREW FOR SEAT ALLUMINIUM 6x26	1
88	011420180 000	CERCHIO RUOTA POSTERIORE 10"	REAR RIM 10"	1
89	1321150 000	DADO ESAGONALE PER RUOTE POSTERIORE	FRONT AND REAR WHEEL NUT	2
90	1801653 000	PROLUNGA PULSANTE MASSA	ENGINE POWER OFF WIRE	1